



SAVSAN MAKİNA A.Ş.

Permanent Solutions Moving Past to Future



Kayseri OSB. 24. Cadde No:97 38070 Kayseri/TURKEY

Tel: +90 352 4423000 Faks: +90 352 4422813 info@savsan.com, www.savsan.com

Three vertical colored squares: green, orange, and red.

Introduction Plan

- *History*
- *Vision*
- *Facility and Personnel Capacity*
- *Organization Chart*
- *Quality System*
- *Business Range*
- *Capabilities*
- *Machine Park*
- *Recent Important Productions and Projects*
- *Sample of Our References*



History



- *Savsan A.Ş. was constructed in 2001 with a with the scope of focusing in domestic and national production of Turkey.*
- *Our company began production of cable production machineries. Following years we have included Baby Diaper Production Lines, Defense Industry Productions and special design productions for specific customer requests.*
- *For Defense Industry first productions and projects were delivered to 2nd MMC of Land Forces and 2nd ASMC of Air Force.*
- *In 2005, as representative we have delivered SKODA and HEXAGON machines to Secreteriat of Defense in scope of M60 Modernization Project.*
- *For Tübitak and MKEK, we have produced mechanical parts of various bombs and rockets in addition to other mechanical parts productions.*
- *In 2017, we began delivering mobile rocket launching platform TAMKAR to MKEK.*
- *For petrochemical refineries and oil industry, we are producing systems and spare parts mainly from Stainless Steel, Monel, Hastelloy and other precious alloys.*



Vision



- *In addition to developing an international customer oriented approach in machinery design and production; obtaining a Reliable and Sustainable position in Defense Industry by building Brand Equity.*



Facility and Personnel Capacity



Engineer / Director	9
Professional	19
Administrative Staff	4
Total	32





Facility and Personnel Capacity



Closed Area	3 300 m²
Open Area	1 700 m²
Total	5 000 m²



**24.
Street**

Savsan A.Ş.

**Kayseri OSB
Adana
(South) Exit**



Organization Chart

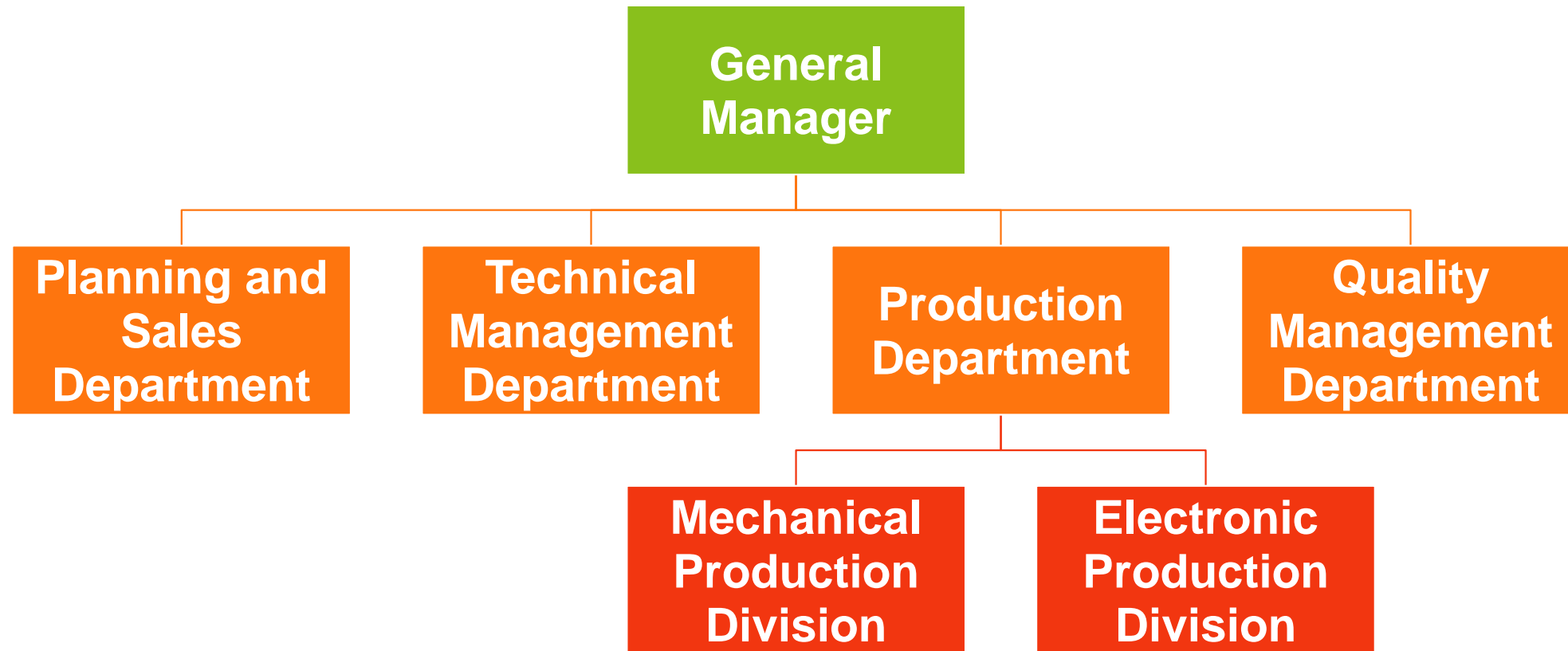

Quality System



- **Quality Policy of our company that is also certified with ISO 9001:2015**
“Meeting customer needs and expectations in parallel with constant improvements, in a punctual, qualified, economical and consistent way.”



Three vertical colored squares: green, orange, and red.

Business Range

- ***Design and R&D,***
- ***Machinery Production***
- ***Project Management and Consultancy,***
- ***Turn-Key Deliveries of special projects focused on customer demand,***
- ***PLC and SCADA Software Development,***
- ***Machining,***
- ***Maintenance and Service,***
- ***Agency***



Capabilities



- *In scope of Customers' Demands;*
 - *Designing of Machines and Systems,*
 - *Production of Designed Systems,*
 - *Turn-Key Project Deliveries of Produced Systems,*
- *Project Management of Complex Systems / Machineries as Turn-Key deliveries including Procurement, Assembling and Starting-Up,*

Capabilities



- *Producing Software for Systems/Machineries including complete automation and adopting to current systems,*
- *Capability to design and verify solid models at Computer,*

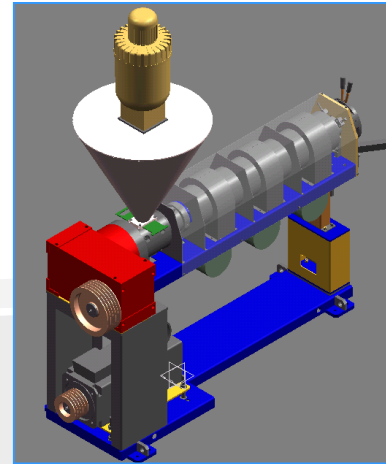
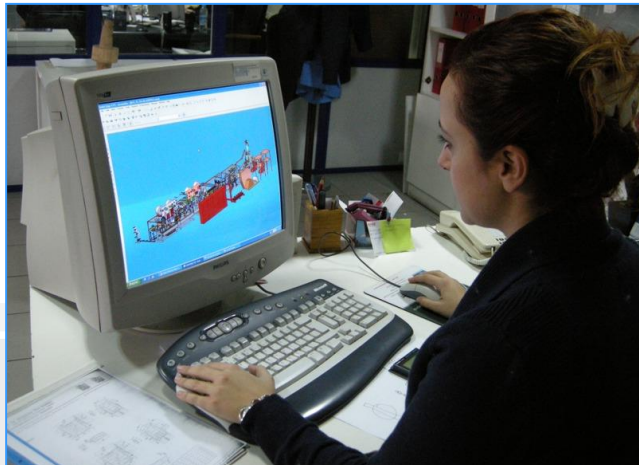



Capabilities



- *To supply Maintenance, Service, Repairing and Technical Support for delivered Systems,*



Machine Park



<i>Or No</i>	<i>Machine Name</i>	<i>Qty</i>
<i>1</i>	<i>MAZAK SQT-15MS CNC Lathe</i>	<i>1</i>
<i>2</i>	<i>MAZAK AJV-32 / 605 N CNC Vertical Milling</i>	<i>1</i>
<i>3</i>	<i>MAZAK QT 35 N x 1500 CNC Lathe</i>	<i>1</i>
<i>4</i>	<i>MAZAK MAZATECH H-800 CNC Horizontal Milling</i>	<i>1</i>
<i>5</i>	<i>MAZAK QT 8 N CNC Lathe</i>	<i>1</i>
<i>6</i>	<i>MAZAK MAZATECH HTC-400 CNC Horizontal Milling</i>	<i>6</i>

Machine Park



<i>Or No</i>	<i>Machine Name</i>	<i>Qty</i>
<i>7</i>	<i>MAZAK MAZATECH VTC-16A Vertical Milling</i>	<i>1</i>
<i>8</i>	<i>MAZAK MAZATECH H630-N Horizontal Milling</i>	<i>1</i>
<i>9</i>	<i>MAZAK MAZATECH FH480 Horizontal Milling</i>	<i>1</i>
<i>10</i>	<i>TAKSAN Horizontal Surface Grinding</i>	<i>1</i>
<i>11</i>	<i>DEA HEXAGON MISTRAL 3 Axis Coordinate Measuring</i>	<i>1</i>
<i>12</i>	<i>WMW UNION SA 6U Cylindrical Grinding</i>	<i>1</i>

Machine Park



<i>Or No</i>	<i>Machine Name</i>	<i>Qty</i>
<i>13</i>	<i>TAKSAN FSS 400/2 Vertical Milling</i>	<i>1</i>
<i>14</i>	<i>TAKSAN BN 102 B Universal Grinding</i>	<i>1</i>
<i>15</i>	<i>UNION BFT 80/3 BOHRWERK Horizontal Holing and Milling</i>	<i>1</i>
<i>16</i>	<i>UNION BF 80 BOHRWERK Horizontal Holing and Milling</i>	<i>1</i>
<i>17</i>	<i>COLLET 115 Horizontal Holing and Milling</i>	<i>1</i>
<i>18</i>	<i>TEZSAN SN 71/4000 Universal Lathe</i>	<i>1</i>

Machine Park



<i>Or No</i>	<i>Machine Name</i>	<i>Qty</i>
<i>19</i>	<i>TEZSAN SN 71/3000 Universal Lathe</i>	<i>2</i>
<i>20</i>	<i>TEZSAN SN 50/2000 Universal Lathe</i>	<i>3</i>
<i>21</i>	<i>TOS Revolver Lathe</i>	<i>1</i>
<i>22</i>	<i>SCHENCK H30N/3 Horizontal Balancing</i>	<i>1</i>
<i>23</i>	<i>SCHENCK CBAD Vertical Balancing</i>	<i>1</i>

Recent Important Productions and Projects



TÜBİTAK Projects

- *Military Laptop and Telephone Boxes Production (Tübitak UEKAE),*
- *NBC Fabrics Manufacturing Machine Production (Tübitak MAM),*



Recent Important Productions and Projects



TÜBİTAK Projects

- *As a part of GENESIS project, Military Ships' Battle Management Systems Production (Tübitak UEKAE),*
- *Mine Detector Mechanic and Composite Parts Production (Tübitak MAM)*



Recent Important Productions and Projects



TÜBİTAK Projects

- *Multi Rocket Launching Body Production (Tübitak SAGE),*
- *Dump/Cluster Bombs' Mechanical Parts Production (Tübitak SAGE),*
- *Cannon Barrel Backfiring Measuring Stand Production (Tübitak SAGE),*

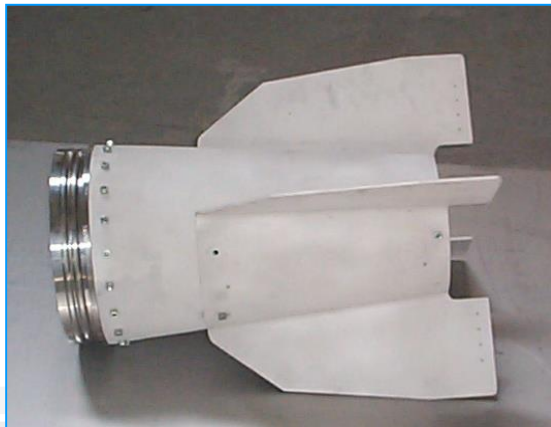
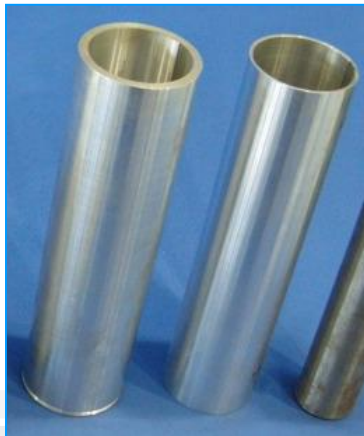

Recent Important Productions and Projects



TÜBİTAK Projects

■ *War Head*



Recent Important Productions and Projects



TÜBİTAK Projects

- *Mass Equivalent (MK-83)*



Recent Important Productions and Projects



TÜBİTAK Projects

- *Mass Equivalent (MK-83)*



Recent Important Productions and Projects



TÜBİTAK Projects

- *Mass Equivalent (MK-83)*



Recent Important Productions and Projects



TÜBİTAK Projects

- *Mass Equivalent (MK-82)*



Recent Important Productions and Projects



TÜBİTAK Projects

- *Exhibition Model and Tail Complete for Exhibition*



Recent Important Productions and Projects



TÜBİTAK Projects

- *Exhibition Model and Tail Complete for Exhibition*



Recent Important Productions and Projects



TÜBİTAK Projects

■ «Camgöz» Prototype Production



Recent Important Productions and Projects



TÜBİTAK Projects

- *Mechanical Productions for SOM Project*



Recent Important Productions and Projects



TÜBİTAK Projects

■ Tail Wings and Head Production

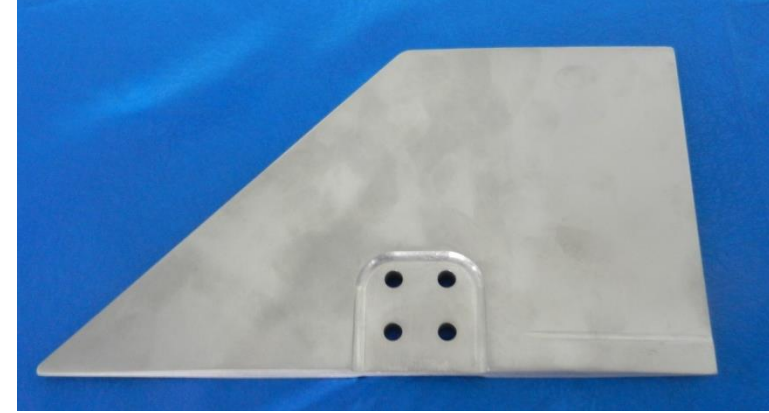
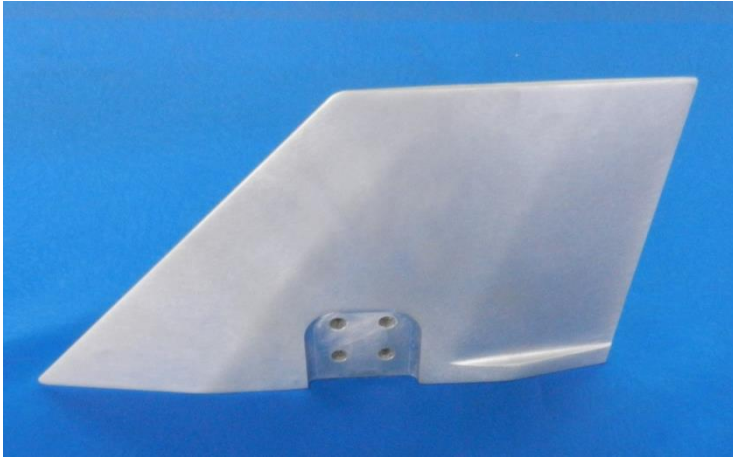

Recent Important Productions and Projects



Projects for Air Force Command

- *C-130 Fire Extinguishing Kit Joint Project for Designing and Producing (2nd Air Supply and Maintenance Center Command),*
- *C-130 Fire Extinguishing Kit Transfer Trailer Design and Production (2. ASMC),*
- *C-130 Fire Extinguishing Kit Retardant Mixer Production (2. ASMC),*



Recent Important Productions and Projects



Projects for Air Force Command

- *Bomb Disposal Water Gun Production(2.ASMC),*
- *“For Project Altın Kanatlar (Golden Wings)” Plane Procurement of Engine (2. ASMC – Turkish Radio Television)*
- *Transportation Containers Production for Turkish Air Force Turkish Stars Acrobatics for C-130/C-160,*



Recent Important Productions and Projects



Projects for Air Force Command

- *CN-235 CASA “Manş” Target System Design and Production (2.ASMC),*
- *Dummy Bomb production for F-5 Aircrafts (1.ASMC),*
- *Procurement and Installation of Universal Hydraulic Test Stand (1.ASMC)*



Recent Important Productions and Projects



Projects for Air Force Command

- *Manual Hydraulic Hand Pump Production*
- *Automatic Tail Door Production for KC-135/C-130 Aircrafts' Maintenance Hangar (2.ASMC),*



Recent Important Productions and Projects



Projects for Turkish Land Forces

- *As a part of M-60 Tanks' Modernization Project;*
 - *Turn-Key delivery of 5 Axis Universal CNC Bohrwerk Machines for M-60 Tank Body Machining including Infrastructure; Servicing & Maintenance (2nd MMC)*

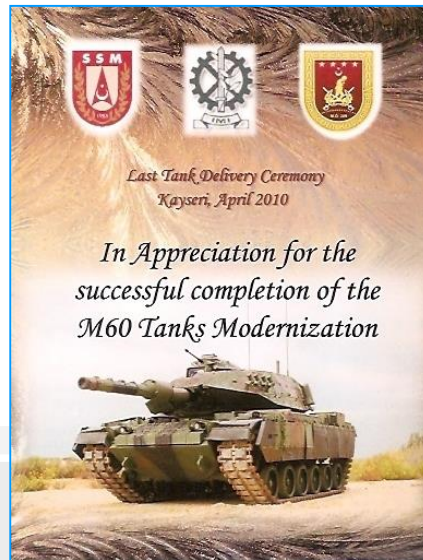

Recent Important Productions and Projects



Projects for Turkish Land Forces

- *As a part of M-60 Tanks' Modernization Project;*
 - *Turn-key delivery of 3 Axis Coordinate Measuring Machine including Infrastructure, Special Cabin, Loading System with Rail; Servicing & Maintenance (2nd MMC)*

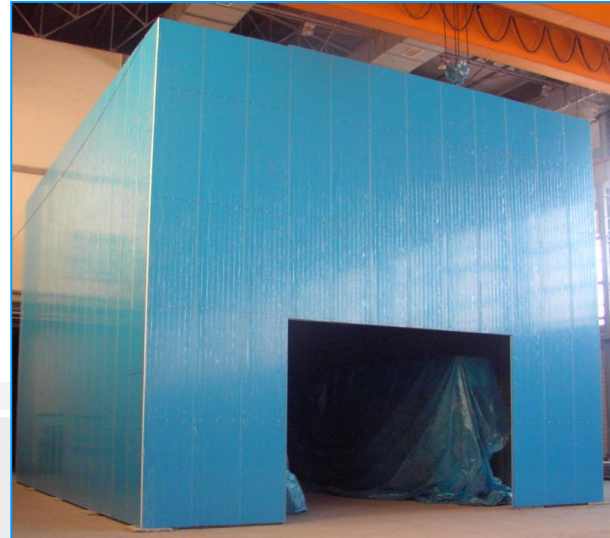

Recent Important Productions and Projects



Projects for Turkish Land Forces

- *As a part of M-60 Tanks' Modernization Project;*
 - *Special Fixture Production (2nd MMC),*
 - *Barrel Backfiring Test Systems Installation (STM),*
 - *Special Parts Production, Machining and Correction (IMI),*



Recent Important Productions and Projects



Projects for Turkish Land Forces

- *Smoke Mortar System Kits Production for Armored Military Vehicles,*
- *Main Cylinder Production for Bridge Tanks (2nd MMC)*



Recent Important Productions and Projects



Projects for Turkish Land Forces

- *Procurement and Installation of Spectro Oil Analyzing Machines (2nd MMC),*
- *De-Humidifier Machine Procurement and Installation (2nd MMC),*



Recent Important Productions and Projects



Projects for Turkish Land Forces

- *M-60 Tanks' Turret Gear System Production (2nd MMC),*
- *Motor Loading/Unloading Equipment Production (2nd MMC,*
- *Assault Engineer Vehicle «Boom System» Production (2nd MMC),*



Recent Important Productions and Projects



Projects for Turkish Land Forces



M113 ZPT
Transmisyonu
Gövde ve Kapakları

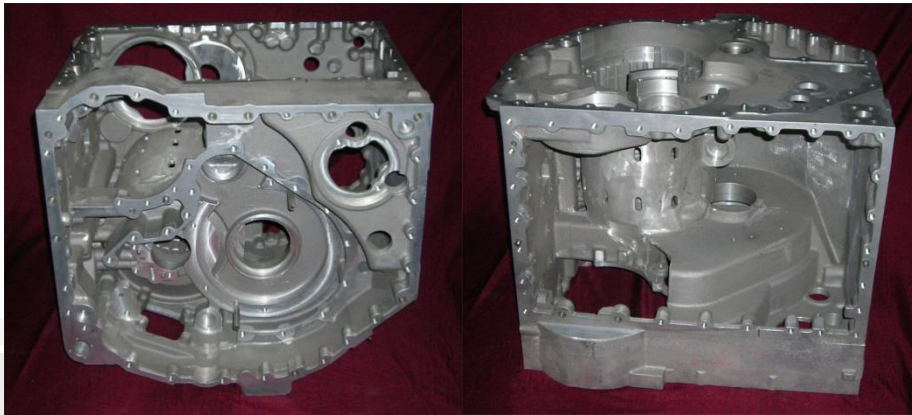

Recent Important Productions and Projects



Projects for Turkish Land Forces

- *HEC SHK 7000 Shock Absorber Test System Procurement and Installation (2nd MMC),*



Recent Important Productions and Projects



MKE Projects

- *TAMKAR Rocket and Launcher System (MKEK)*



Recent Important Productions and Projects



MKE Projects

- *Penetrator Bomb (NEB)*



Recent Important Productions and Projects



MKE Projects

- *Cannon Backfire Measuring System Production,*
- *G-3 Barrel Production (Silahsan),*
- *MG-3 Parts Production (Silahsan),*
- *40 mm. Bomb Launcher Body Production(Silahsan),*
- *Toros 2000 Rocket Launcher Prototype and Mold Production,*



Recent Important Productions and Projects



Cable Production Lines and Machines



Recent Important Productions and Projects



Cable Production Lines and Machines

- *Insulation Lines (Up to 2000 m/min)*
- *Sheathing Lines*
- *Fiber Optic Cable Production Lines*
- *Lan Cable Production Lines*
- *Cable Twisting Lines*
- *Cable Marking Lines*
- *Cable Packing Lines*
- *Cable Rewinding Lines*
- *Special Twisting Lines for new Type Fiber Optic Cables*

Recent Important Productions and Projects



Cable Production Lines and Machines



Recent Important Productions and Projects



Cable Production Lines and Machines

- *Pay-Offs*
Flyer Type Portal Type Gantry Type Basic Type Rod Pay-off
- *Multi-Fiber Pay-Off*
- *Extruders*
- *Capstans and Caterpillars*
- *Cooling Through (Hot/Cold; Movable/Fixed)*
- *Vertical and Horizontal Accumulators*
- *Take-Ups*
Portal Type Gantry Type Basic Type
- *Full and Semi-Automatic Dual Take-Ups*
- *Line Control Systems and Software*

Recent Important Productions and Projects



Cable Production Lines and Machines



Recent Important Productions and Projects



Baby Diaper Production Lines and Machineries

- *Panel (I) Type Half Servo Production Lines (400 pcs/min)*
- *T-Shape Full Servo Production Lines (600 pcs/min)*
- *Hammermill*
- *Stacker*



Recent Important Productions and Projects



Steel Pipe Machinery

■ Automatic Threading Machine

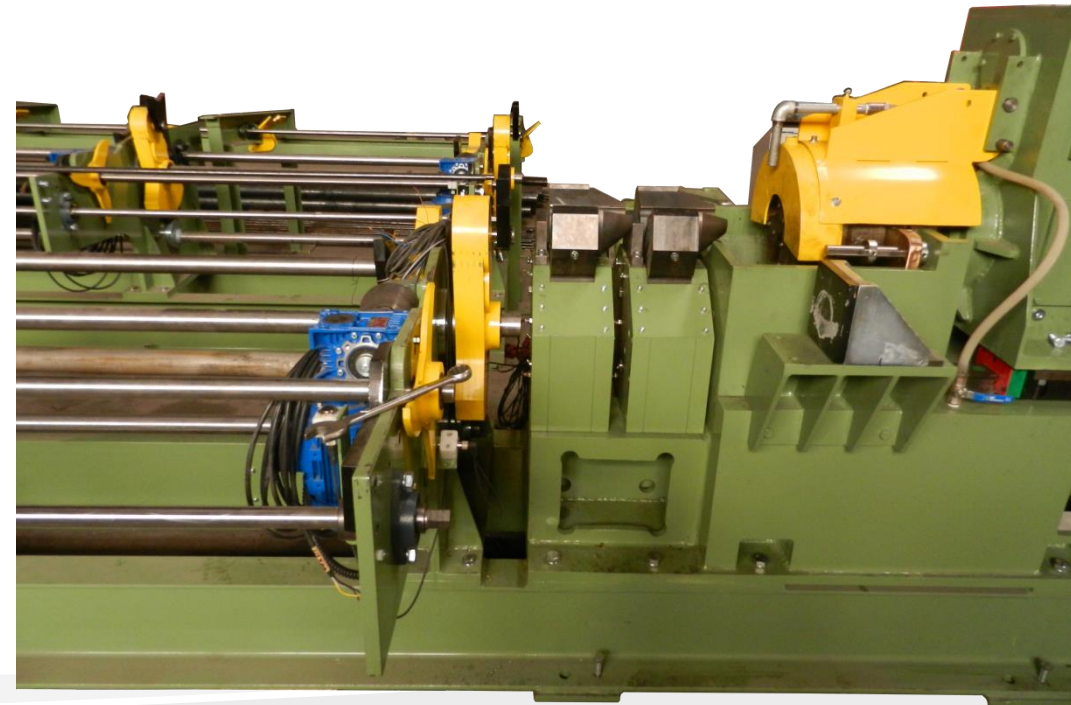

Recent Important Productions and Projects



Productions for Petro-Chemical and Oil Industry

- *Heat Exchangers*
- *Steel and Stainless Steel Pump Spares*
- *Diffusers*
- *Monel and special alloy spare part production*



Recent Important Productions and Projects



Special Design Projects

- *Foam Cutting Machine*
- *Liquid and Powder Detergent Production and Packaging Machinery,*
- *Special Purpose Mold Production,*
- *Felt Cutting Units and Dies Production,*
- *Lamination Extruder Production for Textile Industry*



Recent Important Productions and Projects



Special Design Projects

- *Main Frame and Moving Mechanical Hardware Production for Solar Powered Prototype Car Erciyes TYEK-G*
- *Composite Wrapping Mold Production*
- *Spectro Oil Analyzing Device*



Recent Important Productions and Projects



Mechanical Productions

- *Parts for Civil Vehicles (Trucks, Cars, Tractors)*
- *Military Parts*
- *Screw, Barrel and Extrusion Heads*

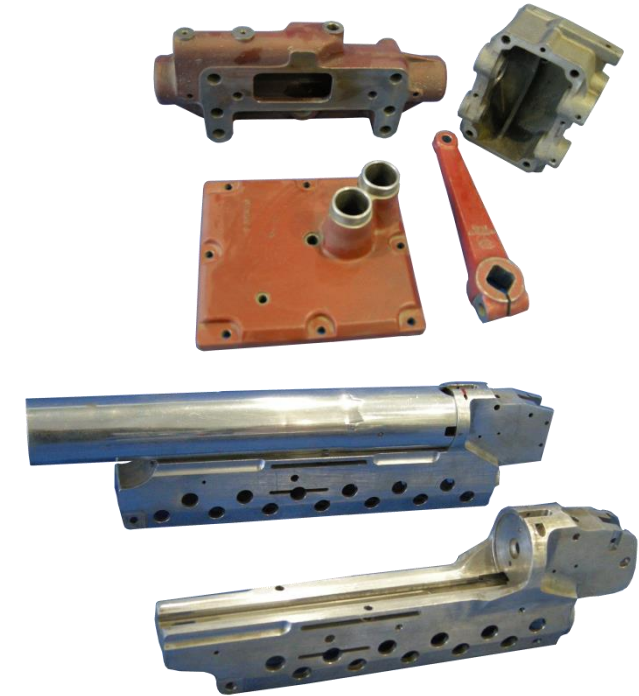

Some of Certificates



* For Quality System Certificates, please contact our sales department

Some of Our References



** For detailed reference list, you can contact our sales department*

Contact Info



Kayseri OSB. 24 Cadde No.97 38070 Kayseri/Türkiye

Tel: +90 352 4423000 Faks: +90 352 4422813 info@savsan.com , www.savsan.com



SAVSAN MAKİNA A.Ş.

Permanent Solutions Moving Past to Future



Kayseri OSB. 24. Cadde No:97 38070 Kayseri/TURKEY

Tel: +90 352 4423000 Faks: +90 352 4422813

info@savsan.com, www.savsan.com